



Tel: **0800 975 4933**

Sales: [sales@avantauk.com](mailto:sales@avantauk.com)



# WORKBENCHES



quality products made in the UK

# PREMIER 1 WORKBENCH RANGE

A flat pack modular workbench system with a weight capacity of 450kg UDL. All workbenches are 840mm high as standard, other heights available. All Premier workbench frames, cabinet and drawer carcasses are epoxy polyester powder coated in Mid Grey RAL 7001. All premier cabinet doors and drawers are epoxy polyester powder coated in Premier Blue.

## WORKTOPS

- A = 30mm thick hardwood veneer top.
- B = 30mm thick industrial marble grey lino.
- C = 25mm thick plain cut MDF.

## WORKBENCHES

L x W(mm)	Top	Code	£
1500 x 600	Veneer	PW156A	197.18
1500 x 700	Veneer	PW157A	233.65
1500 x 600	Lino	PW156B	245.78
1500 x 700	Lino	PW157B	287.13
1500 x 600	MDF	PW156C	163.35
1500 x 700	MDF	PW157C	200.26
2000 x 600	Veneer	PW126A	240.31
2000 x 700	Veneer	PW127A	284.19
2000 x 600	Lino	PW126B	301.32
2000 x 700	Lino	PW127B	360.34
2000 x 600	MDF	PW126C	209.70
2000 x 700	MDF	PW127C	250.18

## ACCESSORIES

L x W(mm)	Description	Code	£
1500 x 600	Base Shelf	PW156BS	46.66
1500 x 600	Base Shelf / Mat	PW156BM	87.20
1500 x 700	Base Shelf	PW157BS	51.35
1500 x 700	Base Shelf / Mat	PW157BM	91.87
2000 x 600	Base Shelf	PW126BS	62.29
2000 x 600	Base Shelf / Mat	PW126BM	106.32
2000 x 700	Base Shelf	PW127BS	68.42
2000 x 700	Base Shelf / Mat	PW127BM	114.74

## CASTOR SET (Factory Fitted)

Set of 4x rubber tyred castors fitted. 2x fixed & 2x swivel braked. (300Kg UDL capacity)

Diameter(mm)	Code	£
100	PW4SC	66.07

## CABINETS

H / Drawer(mm)	Code	Shelves	Drawers	£
	PC1	2		204.79
150	PC2	1	1	251.19
150/100	PC4		3/1	410.63

## DRAWERS

H(mm)	Drawers	Code	£
150	1	PD1A	155.85
350	1	PD1B	190.61
150	2	PD2	272.72

## PREMIER 1 WORKBENCH RANGE

Simple flat pack assembly for a basic bench 600mm wide including all assembly fixings



1500 x 600 c/w lino worktop  
PW156B £245.78

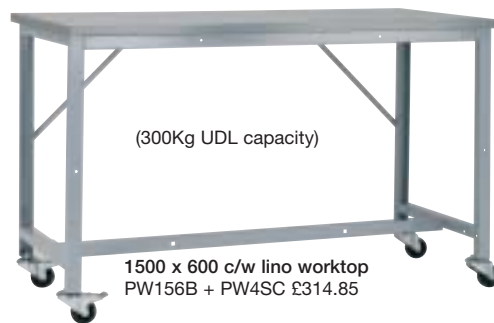

1500 x 600 c/w lino worktop  
PW156B + PW4SC £314.85

All cabinets & drawers have central locking facility and are manufactured from 0.9mm thick steel sheet.

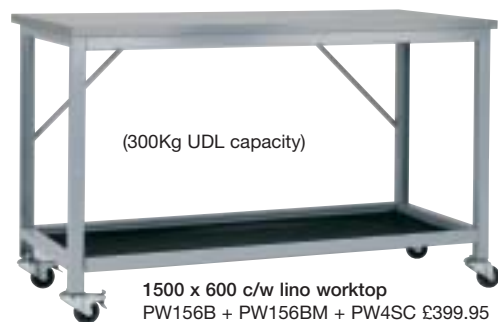

1500 x 600 c/w lino worktop  
PW156B + PW156BM + PW4SC £399.95

## PREMIER UNDERBENCH CABINETS

650mm high, 500mm wide & 500mm deep. All cabinets secured by semi-flush fit locking handle and come complete with perforated tool panel and adjustable shelf.



PC1

PC2

PC4

## PREMIER UNDERBENCH DRAWERS

500mm wide x 500mm deep.  
PD1A = 225mm high PD1B = 425mm high  
All drawers are mounted on precision ball bearing telescopic slides (capacity 40kg UDL)



PD1A

PD1B

PD2

# PREMIER 1 WORKBENCH RANGE



1500 x 600 c/w veneer worktop  
PW156A + PW156BM £284.38



1500 x 600 c/w veneer worktop  
PW156A + PC1 £401.99



1500 x 600 c/w lino worktop  
PW156B + PC2 £496.96

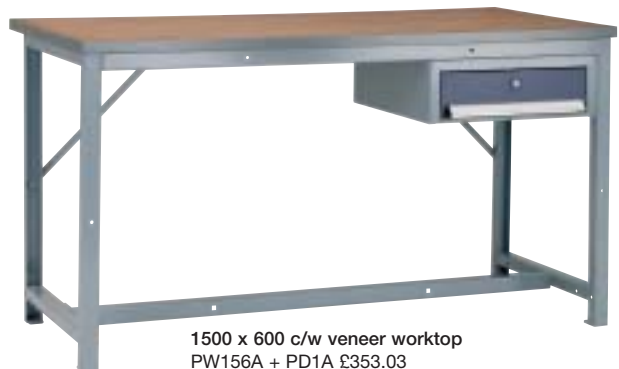

1500 x 600 c/w veneer worktop  
PW156A + PD1A £353.03



1500 x 600 c/w lino worktop  
PW156B + PC4 £656.41



1500 x 600 c/w lino worktop  
PW156B + PD1A £401.63



1500 x 600 c/w lino worktop  
PW156B + PD2 £518.50



1500 x 600 c/w veneer worktop  
PW156A + PD1A + PC1 £557.90

**450KG UDL**

Construction from fabricated steel section with welded leg supports and multi position cross rail.



If not standard, please specify colour choice at time of order



# PREMIER 2 WORKBENCH RANGE

A flat pack heavy duty modular workbench system with a weight capacity of 700kg UDL. All workbenches are 840mm high as standard, other heights available on request. All Premier workbench frames are epoxy polyester powder coated in Mid Grey RAL 7001. Cabinets/drawers Premier Blue.

## WORKTOPS

- A = 30mm thick hardwood veneer top.
- B = 30mm thick industrial marble grey lino.
- C = 25mm thick plain cut MDF.

## WORKBENCHES

L x W(mm)	Top	Code	£
1500 x 700	Veneer	PW257A	255.49
1500 x 700	Lino	PW257B	306.03
1500 x 700	MDF	PW257C	225.41
2000 x 700	Veneer	PW227A	300.97
2000 x 700	Lino	PW227B	380.94
2000 x 700	MDF	PW227C	261.67

## CABINETS

H / Drawer(mm)	Code	Shelves	Drawers	£
	PC1	2		204.79
150	PC2	1	1	251.19
150/100	PC4		3/1	410.63

## DRAWERS

H(mm)	Drawers	Code	£
150	1	PD1A	155.85
350	1	PD1B	190.61
150	2	PD2	272.72

## ACCESSORIES

### ACCESSORY POSTS

PWAP1	1000mm high to accommodate combination back panel	£56.32
PWAP2	1500mm high to accommodate back panel and upper shelf	£60.78
PWAP3	2000mm high to accommodate back panel, upper shelf and light	£65.21

### SERVICE DUCT

PWSD15	1500mm long service duct with 2 x 2 13amp double sockets	£68.11
PWSD20	2000mm long service duct with 2 x 2 13amp double sockets	£71.56

### COMBINATION BACK PANELS 450MM HIGH

PWCP15	1500mm long back panel 1/2 louvred 1/2 perforated	£78.14
PWCP20	2000mm long back panel 1/2 louvred 1/2 perforated	£107.55

### UPPER SHELVES

PWUSS15	1500mm long steel upper shelf	£54.26
PWUSS20	2000mm long steel upper shelf	£65.46

### LIGHT BAR WITH 1200MM STRIP LIGHT\*

PWLU15	1500mm long supplied with diffuser	£96.10
PWLU20	2000mm long supplied with diffuser	£108.39

\*All electrics are supplied unwired, for fitting by a suitably qualified electrician

## PREMIER 2 WORKBENCHES

### HEIGHT

All workbenches 840mm high.

### AVAILABLE IN 2 SIZES

1500mm length x 700mm wide  
2000mm length x 700mm wide

### 3 WORKTOPS

- A = 30mm thick Veneer
- B = 30mm thick Lino
- C = 25mm thick plain cut MDF



## PREMIER UNDERBENCH CABINETS

650mm high, 500mm wide & 500mm deep.  
All cabinets secured by semi-flush fit locking handle and come complete with perforated tool panel and adjustable shelf.



## PREMIER UNDERBENCH DRAWERS

500mm wide x 500mm deep.  
PD1A = 225mm high      PD1B = 425mm high  
All drawers are mounted on precision ball bearing telescopic slides (capacity 40kg UDL)



# WELDING WORKBENCH RANGE

A range of Flat Pack Heavy Duty Welding Workbench system with a weight capacity of 700kg UDL. All workbenches are 840mm high as standard, other heights available on request.

## PREMIER 2 TYPE WELDING BENCH 1500 X 700 X 840 - PWB257FBSL



£349.99

Heavy Duty Framework designed to meet the toughest of environments.

Its rugged construction is well suited to industrial and educational use is maintenance free.

Option 1 - 1/2 refractory fire brick - 1/2 slatted worktop.

Flat pack - ideal for export.



1500 x 700 c/w lino worktop  
PW257B  
£306.03



1500 x 700 c/w lino worktop  
PW257B + PD1A + PC1

## PREMIER 2 TYPE WELDING BENCH 1500 X 700 X 840 - PWB257FBST

Heavy Duty Framework designed to meet the toughest of environments.

Option 1 - 1/2 refractory fire brick - 1/2 steel worktop.

Flat pack - ideal for export.

£349.99



## PREMIER 2 TYPE WELDING BENCH 1500 X 700 X 840 - PWB257STSL



£349.99

Heavy Duty Framework designed to meet the toughest of environments.

Its rugged construction is well suited to industrial and educational use is maintenance free.

Option 1 - 1/2 steel - 1/2 slatted worktop.

Flat pack - ideal for export.



1500 x 700 c/w lino worktop  
PW257B + PC2  
£557.22



# PREMIER 3 SQUARE TUBE & PREMIER 4 CANTILEVER WORKBENCHES

Welded construction from 30mm thick square and rectangular tube steel with a choice of worktops & accessories. The benches will arrive on site built up with above the work surface accessories supplied loose. All workbenches are 840mm high as standard, other heights available. Mid Grey RAL 7001 Frames with Premier Blue Doors/Drawers.

**ACCESSORY POSTS**

PAP1	1000mm high to accommodate combination back panel	£56.32
PAP2	1500mm high to accommodate back panel & upper shelf	£60.78
PAP3	2000mm high to accommodate back panel, upper shelf & light	£65.21

**SERVICE DUCT\***

PSD15	1500mm long service duct with 2 x 2 13amp plug sockets	£68.11
PSD18	1800mm long service duct with 2 x 2 13amp plug sockets	£71.56

**COMBINATION BACK PANELS 450MM HIGH**

PCP15	1500mm long back panel louvred & perforated	£78.14
PCP18	1800mm long back panel louvred & perforated	£97.55

**UPPER SHELVES**

PUSS15	1500mm long steel upper shelf	£54.26
PUSS18	1800mm long steel upper shelf	£65.46

**BASE SHELVES**

PBS15	1500mm long steel base shelf	£71.15
PBS18	1800mm long steel base shelf	£77.06

**LIGHT BAR WITH 1200MM STRIP LIGHT\***

PLU15	1500mm long supplied with diffuser	£96.10
PLU18	1800mm long supplied with diffuser	£98.39

\*All electrics are supplied unwired, for fitting by a suitably qualified electrician

**WORKTOPS**

A = 18mm thick hardwood veneer. 2mm veneer surface on 16mm composite core. Edge banded in 2mm thick grey plastic  
 B = 18mm thick industrial marble grey lino. 2mm veneer surface on 16mm composite core. Edge banded in 2mm thick grey plastic

**WORKBENCHES (Square Tube)**

L x W(mm)	Top	Code	£
1500 x 600	Veneer	PW356A	312.35
1500 x 750	Veneer	PW357A	359.24
1500 x 600	Lino	PW356B	312.17
1500 x 750	Lino	PW357B	333.15
1800 x 600	Veneer	PW386A	312.13
1800 x 750	Veneer	PW387A	356.90
1800 x 600	Lino	PW386B	318.30
1800 x 750	Lino	PW387B	336.42

**WORKBENCHES (Cantilever)**

L x W(mm)	Top	Code	£
1500 x 600	Veneer	PW456A	334.64
1500 x 750	Veneer	PW457A	389.60
1500 x 600	Lino	PW456B	344.58
1500 x 750	Lino	PW457B	364.65
1800 x 600	Veneer	PW486A	344.54
1800 x 750	Veneer	PW487A	387.34
1800 x 600	Lino	PW486B	350.44
1800 x 750	Lino	PW487B	367.79

**CABINETS**

H / Drawer(mm)	Code	Shelves	Drawers	£
	PC1	2		204.79
150	PC2	1	1	351.19
150/100	PC4		3/1	410.63

**DRAWERS**

H(mm)	Drawers	Code	£
150	1	PD1A	155.85
350	1	PD1B	190.61
150	2	PD2	272.72

**PREMIER 3 SQUARE TUBE & PREMIER 4 CANTILEVER WORKBENCHES**



1800 x 750 c/w lino worktop  
 Order code: PW387B +  
 PC2 Cabinet / drawer  
 PSD18 Service duct\*  
 PAP3 Accessory posts  
 PCP18 Combination panel  
 PUSS18 Upper shelf  
 PLU18 Light bar\*

PRICE £879.67



1800 x 750 c/w lino worktop  
 Order code: PW487B +  
 PC2 Cabinet / drawer  
 PSD18 Service duct\*  
 PAP3 Accessory posts  
 PCP18 Combination panel  
 PUSS18 Upper shelf  
 PLU18 Light bar\*

PRICE £908.59  
 bins & clips not inc.

**PREMIER UNDERBENCH CABINETS**

650mm high, 500mm wide & 500mm deep.  
 All cabinets secured by semi-flush fit locking handle and come complete with perforated tool panel and adjustable shelf.



PC1

PC2

PC4

**PREMIER UNDERBENCH DRAWERS**

500mm wide x 500mm deep.  
 PD1A = 225mm high PD1B = 425mm high  
 All drawers are mounted on precision ball bearing telescopic slides (capacity 40kg UDL)



PD1A

PD1B

PD2



If not standard, please specify colour choice at time of order



# PREMIER MODULAR PEDESTAL WORKBENCHES

Flat pack modular workbench system offering a variety of storage and workspace solutions. Leg frames are constructed from fabricated steel section to bolt to the worktop. 650mm high premier units are mounted on 150mm high steel plinths. All cabinets are lockable and contain 1 adjustable shelf. All drawers are mounted on precision ball bearing telescopic slides offering a 40Kg (UDL) capacity. Mid Grey RAL 7001 Frames with Red 3020 Doors/Drawers.

## WORKBENCHES

### 1500mm Length x 600mm Wide

Combination	Code	£
PLU600+PPC1+W56B	Model 1	390.61
PLU600+PPC2+W56B	Model 2	437.01
PLU600+PPC4+W56B	Model 3	596.45
PPC4+PPC1+W56B	Model 4	775.48
PPC4+PPC4+W56B	Model 5	981.30
PPC4+PPC2+W56B	Model 6	821.86
PPC2+PPC2+W56B	Model 7	662.42
PPC4+PPC4+PPC4+W56B	Model 8	1479.93
PPC2+PPC2+PPC4+W56B	Model 9	1124.37

### 3000mm Length x 600mm Wide

Combination	Code	£
PPC1+PPC4+PPC2+W56B+W56B	Model 10	1,153.70
PPC1x2+PPC2x2+PPC4x2+W56Bx2	Model 11	2,155.66

## WORKTOPS

H x W x D(mm)	Top	Code	£
30 x 1500 x 600	Veneer	W56A	87.03
30 x 2000 x 600	Veneer	W26A	96.75
30 x 1500 x 600	Lino	W56B	94.07
30 x 2000 x 600	Lino	W26B	158.63

## ACCESSORIES

H x W x D(mm)	Description	Code	£
800 x N/A x 500	Leg Unit	PLU600	58.76
800 x 500 x 500	Cabinet	PPC1	237.78
800 x 500 x 500	Cabinet / Drawer	PPC2	284.02
800 x 500 x 500	4 Drawer Unit	PPC4	461.96



MODEL 1: PLU600 + PPC1 + W56B  
£390.61



MODEL 2: PLU600 + PPC2 + W56B  
£437.01



MODEL 3: PLU600 + PPC4 + W56B  
£596.45



MODEL 4: PPC4 + PPC1 + W56B  
£775.48

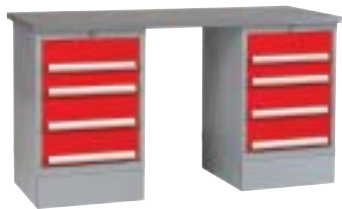

MODEL 5: PPC4 + PPC4 + W56B  
£981.30



MODEL 6: PPC4 + PPC2 + W56B  
£821.86



MODEL 7: PPC2 + PPC2 + W56B  
£662.42

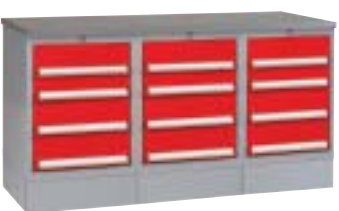

MODEL 8: PPC4 + PPC4 + PPC4 + W56B  
£1479.93



MODEL 9: PPC2 + PPC2 + PPC4 + W56B  
£1124.37

Create a run... Choose your size, storage option, worktop and go.  
All benches are 830mm high. Mid grey (RAL 7001) carcass with colour choice drawers/doors



MODEL 10: PPC1 + PPC4 + PPC2 + W56B + W56B x2  
£1,153.70



MODEL 11: PPC1 x2 + PPC2 x2 + PPC4 x2 + W56B x2  
£2,155.66



# PREM-ECON 1 MEDIUM DUTY WORKBENCHES

Taking the Bedford Premier flat pack workbench frame and adding the standard Bedford underbench storage units makes for a quality yet economic workbench solution. Constructed from fabricated steel section with welded leg supports and multiposition cross rail. Framework powder coated Mid grey RAL 7001 with Blue RAL 5015 doors and drawers front colour.

## WORKBENCHES

L x W(mm)	Top	Code	£
1500 x 700	Veneer	PEW157A	233.65
1500 x 700	Lino	PEW157B	287.13
1500 x 700	MDF	PEW157C	200.26
2000 x 700	Veneer	PEW127A	284.19
2000 x 700	Lino	PEW127B	360.34
2000 x 700	MDF	PEW127C	250.18

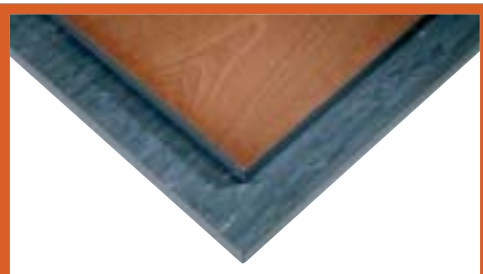

### WORKTOPS

- A = 30mm thick hardwood veneer top.
- B = 30mm thick industrial marbled grey lino.
- C = 25mm thick plain cut MDF.

## PREM-ECON 1 MEDIUM DUTY WORKBENCHES



1500 x 700 c/w lino worktop  
PEW157B + D1 + C1 £501.02



1500 x 700 c/w MDF worktop  
PEW157C £200.26



1500 x 700 c/w lino worktop  
PEW157B + D1 £379.24

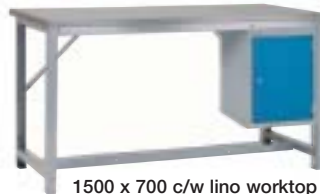

1500 x 700 c/w lino worktop  
PEW157B + C1 £408.91

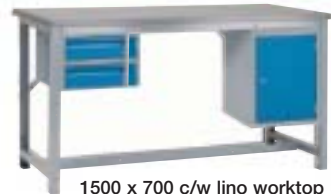

1500 x 700 c/w lino worktop  
PEW157B + D2 + C1 £539.72

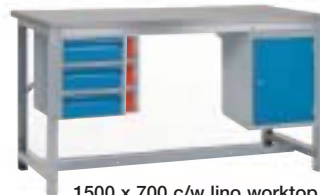

1500 x 700 c/w lino worktop  
PEW157B + D3 + C1 £640.34



1500 x 700 c/w lino worktop  
PEW157B + CD1 £531.32

## DRAWERS & CABINETS

Description	Code	£
Single Drawer	D1	92.11
Double Drawer	D2	165.99
Triple Drawer	D3	231.43
Quad Drawer	D4	336.89
Cabinet Drawer	CD1	244.19
Cabinet	C1	121.78

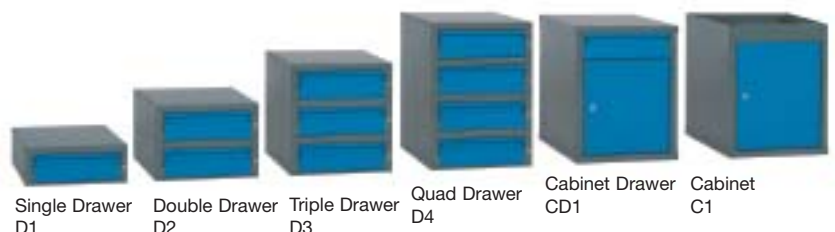

If not standard, please specify colour choice at time of order



# PREM-ECON 1 MOBILE MEDIUM DUTY WORKBENCHES

Take your workbench to the job with a mobile version of the prem-econ workbench system.

## PREM-ECON 1 MEDIUM DUTY WORKBENCHES



### BASE SHELVES

L x W(mm)	Description	Code	£
1500 x 700	Base Shelf	PEW157BS	51.35
1500 x 700	Base Shelf/Mat	PEW157BM	91.87
2000 x 700	Base Shelf	PEW127BS	68.42
2000 x 700	Base Shelf/Mat	PEW127BM	114.74

### CASTORS

Description	Code	£
Set of 4 swivel castors 2 x braked	PW4SC	66.07

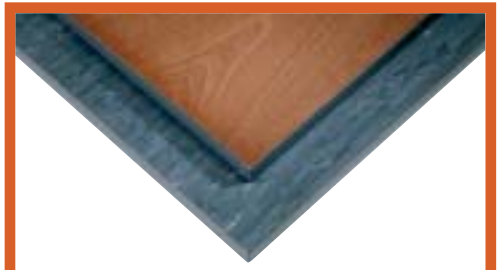

### WORKTOPS

A = 30mm thick hardwood veneer top.

B = 30mm thick industrial marble grey lino.

C = 25mm thick plain cut MDF.

### DRAWERS & CABINETS

Description	Code	£
Single Drawer	D1	92.11
Double Drawer	D2	165.99
Triple Drawer	D3	231.43
Quad Drawer	D4	336.89
Cabinet Drawer	CD1	244.19
Cabinet	C1	121.78



If not standard, please specify colour choice at time of order



# PREM-ECON 2 HEAVY DUTY WORKBENCHES

Taking the Bedford Premier 2 heavy duty flat pack workbench frame and adding the standard Bedford underbench storage units makes for a quality yet economic workbench solution. Framework powder coated Mid grey RAL 7001 with a Blue RAL 5015 door and drawer.

## WORKTOPS

- A = 30mm thick hardwood veneer top.
- B = 30mm thick industrial marble grey lino.
- C = 25mm thick plain cut MDF.

## WORKBENCHES

L x W(mm)	Top	Code	£
1500 x 700	Veneer	PEW257A	255.49
1500 x 700	Lino	PEW257B	306.03
1500 x 700	MDF	PEW257C	225.41
2000 x 700	Veneer	PEW227A	300.97
2000 x 700	Lino	PEW227B	380.94
2000 x 700	MDF	PEW227C	261.67

## ACCESSORIES

### ACCESSORY POSTS

PEWAP1	1000mm high to accommodate combination back panel	£56.32
PEWAP2	1500mm high to accommodate back panel and upper shelf	£60.78
PEWAP3	2000mm high to accommodate back panel, upper shelf and light	£65.21

### SERVICE DUCT

PEWSD15	1500mm long service duct with 2 x 2 13amp double sockets	£68.11
PEWSD18	2000mm long service duct with 2 x 2 13amp double sockets	£71.56

### COMBINATION BACK PANELS 450MM HIGH

PEWCP15	1500mm long back panel 1/2 louvred 1/2 perforated	£78.14
PEWCP20	2000mm long back panel 1/2 louvred 1/2 perforated	£107.55

### UPPER SHELVES

PEWUSS15	1500mm long steel upper shelf	£54.26
PEWUSS20	2000mm long steel upper shelf	£65.46

### LIGHT BAR WITH 1200MM STRIP LIGHT\*

PEWLU15	1500mm long supplied with diffuser	£96.10
PWLU20	2000mm long supplied with diffuser	£108.39

\*All electrics are supplied unwired, for fitting by a suitably qualified electrician

## PREM-ECON 1 MEDIUM DUTY WORKBENCHES



1500 x 700 c/w lino worktop  
PEW257B + D1 + C1 £519.92



1500 x 700 c/w MDF worktop  
PEW257C £225.41



1500 x 700 c/w lino worktop  
PEW257B + CD1 £550.22



1500 x 700 c/w lino worktop  
PEW257B + D3 + C1 £659.24

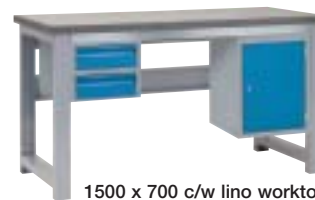

1500 x 700 c/w lino worktop  
PEW257B + D2 + C1 £593.80



1500 x 700 c/w lino worktop  
PEW257B + C1 £472.81



1500 x 700 c/w lino worktop  
PEW257B + D1 £398.14

## DRAWERS & CABINETS

Description	Code	£
Single Drawer	D1	92.11
Double Drawer	D2	165.99
Triple Drawer	D3	231.43
Quad Drawer	D4	336.89
Cabinet Drawer	CD1	244.19
Cabinet	C1	121.78

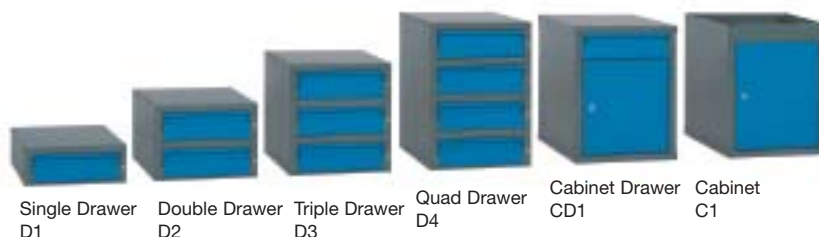

# ESD WORKBENCH ACCESSORIES



Workstation Kits  
see side panel for info & pricing



Configuration Kits  
see side panel for info & pricing



EPA Super Kits  
see side panel for info & pricing

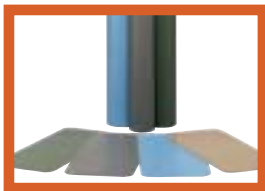

Bench Coverings  
see side panel for info & pricing

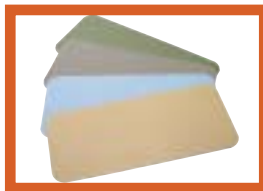

Bench-Saver Mats  
see side panel for info & pricing

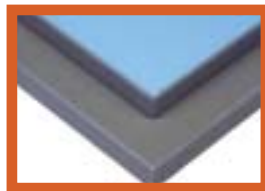

A/S Rubber Worktops  
see side panel for info & pricing



ESD Laminate Worktops  
see side panel for info & pricing



Mat Ground Cord (3m)  
BED-CW-60358 P.O.A



Push & Clinch Snap Socket  
BED-CW-800008 P.O.A



Universal Snap Kit  
BED-CW-80014 P.O.A



Wrist Straps  
see side panel for info & pricing



Leads  
see side panel for info & pricing



Wrist Band  
BED-WE-AY £6.56



Adaptor  
BED-ADP4BP10 £5.95



Male Press Studs (Screw - pk10)  
BED-PSM-10S £3.95



Male Press Studs (Punch - pk10)  
BED-PSM-10 £2.95



Earth Bonding Point Box  
BED-BLB-43 £18.95



Earth Bonding Plate (Press Stud)  
BED-EBB-10 £12.95



Earth Bonding Plate (2BA Terminal)  
BED-EFB-T £15.95



Earth Grounding Label  
BED-GPL-3636 £1.95



Earth Bonding Label  
BED-BPL-3636 £1.95

## WORKSTATION KITS

L x W(mm)	Code	£
1200 x 600	BED-WSK1-1206	87.76
1500 x 600	BED-WSK1-1506	98.32
1800 x 600	BED-WSK1-1806	109.05

## CONFIGURATION KITS

L x W(mm)	Code	£
300 x 200	BED-FCC-0302	30.91
400 x 300	BED-FCC-0403	50.18

## EPA SUPER KITS

L x W(mm)	Code	£
1200 x 600	BED-ESK-1206	302.34
1500 x 600	BED-ESK-1506	319.37
1800 x 600	BED-ESK-1806	336.59

## NEOSTAT C2 FLEXIBLE MATTING

L x W(mm)	Code	£
1200 x 600	BED-BMC2-1206	45.73
1500 x 600	BED-BMC2-1506	57.20
1800 x 600	BED-BMC2-1806	68.51

## NEOSTAT C2 ROLLS

L x W(mm)	Code	£
10m x 1000	BED-BMC2-ROLL1000	581.73
10m x 1200	BED-BMC2-ROLL1200	696.17

## BENCH SAVER MATS

L x W(mm)	Code	£
250 x 200	BED-BSC2-0202	8.94
700 x 300	BED-BSC2-0703	19.79

## ESD WORKTOPS

L x W(mm)	Code	£
1200 x 600	BED-RTN-1206	P.O.A
1200 x 750	BED-RTN-1207	P.O.A
1200 x 900	BED-RTN-1209	P.O.A
1500 x 600	BED-RTN-1506	P.O.A
1500 x 750	BED-RTN-1507	P.O.A
1500 x 900	BED-RTN-1509	P.O.A
1800 x 600	BED-RTN-1806	P.O.A
1800 x 750	BED-RTN-1807	P.O.A
1800 x 900	BED-RTN-1809	P.O.A

please suffix order code for worktop option with:  
G = Grey Rubber - B = Blue Rubber - L = Laminate

## WRIST STRAP (WITH 4MM BANANA PLUG)

L (mm)	Code	£
N/A	BED-WEE-201041Y	17.77

## WRIST STRAP (WITH 10MM PRESS STUD)

L (mm)	Code	£
N/A	BED-WEE-2010101Y	17.77

## LEADS (WITH 4MM BANANA PLUG)

L (mm)	Code	£
N/A	BED-E-201041Y	14.98

## LEADS (WITH 10MM PRESS STUD)

L (mm)	Code	£
N/A	BED-E-2010101Y	14.98

All prices are Ex. Works. Carriage is £15.00



# INFINITE WORKBENCH SYSTEM 1000KG UDL

## INFINITE SYSTEM

Start with a 2m or 3m starter workbench and simply use add-on workbenches and accessories as required.

## STRENGTH & FLEXIBILITY

Framework is constructed from fabricated steel section with welded leg supports and bolt in multi-position cross rails, which can be assembled in a variety of combinations to suit individual applications. Steel work powder coated dark grey (RAL 7031).

### BENCHES (25MM MDF WORKTOP)

All benches are 840mm high as standard.

L x W(mm)	Description	Code	£
2000 x 700	Starter	KDB2078A	345.18
2000 x 700	Starter & Base	KDB2078BSA	409.84
2000 x 1200	Starter	KDB2028A	440.70
2000 x 1200	Starter & Base	KDB2028BSA	537.51
2000 x 1400	Starter	KDB2048A	481.36
2000 x 1400	Starter & Base	KDB2048BSA	635.39
3000 x 700	Starter	KDB3078A	556.23
3000 x 700	Starter & Base	KDB3078BSA	636.46
3000 x 1200	Starter	KDB3028A	684.59
3000 x 1200	Starter & Base	KDB3028BSA	776.59
3000 x 1400	Starter	KDB3048A	778.72
3000 x 1400	Starter & Base	KDB3048BSA	988.38
2000 x 700	Add-On	KDA278A	295.24
2000 x 700	Add-On & Base	KDA278BSA	359.41
2000 x 1200	Add-On	KDA228A	372.26
2000 x 1200	Add-On & Base	KDA228BSA	467.81
2000 x 1400	Add-On	KDA248A	412.18
2000 x 1400	Add-On & Base	KDA248BSA	566.21

### BENCHES (30MM VENEER WORKTOP)

All benches are 840mm high as standard.

L x W(mm)	Description	Code	£
2000 x 700	Starter	KDB2078B	419.31
2000 x 700	Starter & Base	KDB2078BSB	484.04
2000 x 1200	Starter	KDB2028B	501.68
2000 x 1200	Starter & Base	KDB2028BSB	598.50
2000 x 1400	Starter	KDB2048B	555.16
2000 x 1400	Starter & Base	KDB2048BSB	709.51
3000 x 700	Starter	KDB3078B	661.05
3000 x 700	Starter & Base	KDB3078BSB	741.16
3000 x 1200	Starter	KDB3028B	853.60
3000 x 1200	Starter & Base	KDB3028BSB	945.58
3000 x 1400	Starter	KDB3048B	996.94
3000 x 1400	Starter & Base	KDB3048BSB	1,206.59
2000 x 700	Add-On	KDA278B	369.39
2000 x 700	Add-On & Base	KDA278BSB	431.26
2000 x 1200	Add-On	KDA228B	433.72
2000 x 1200	Add-On & Base	KDA228BSB	530.02
2000 x 1400	Add-On	KDA248B	485.99
2000 x 1400	Add-On & Base	KDA248BSB	640.02

### BENCHES (30MM LINO WORKTOP)

All benches are 840mm high as standard.

L x W(mm)	Description	Code	£
2000 x 700	Starter	KDB2078C	437.49
2000 x 700	Starter & Base	KDB2078BSC	502.22
2000 x 1200	Starter	KDB2028C	567.99
2000 x 1200	Starter & Base	KDB2028BSC	664.80
2000 x 1400	Starter	KDB2048C	630.01
2000 x 1400	Starter & Base	KDB2048BSC	785.00
3000 x 700	Starter	KDB3078C	678.17
3000 x 700	Starter & Base	KDB3078BSC	784.41
3000 x 1200	Starter	KDB3028C	894.96
3000 x 1200	Starter & Base	KDB3028BSC	1,036.87
3000 x 1400	Starter	KDB3048C	1,245.45
3000 x 1400	Starter & Base	KDB3048BSC	1,394.71
2000 x 700	Add-On	KDA278C	452.18
2000 x 700	Add-On & Base	KDA278BSC	499.55
2000 x 1200	Add-On	KDA228C	560.87
2000 x 1200	Add-On & Base	KDA228BSC	596.35
2000 x 1400	Add-On	KDA248C	560.63
2000 x 1400	Add-On & Base	KDA248BSC	714.90



2000 x 1400 Starter workbench with MDF worktop & upper shelf unit  
Order code: KDB2048A + PICTURED ACCESSORIES  
US\$235 2000mm Upper Shelf  
**£546.85**

Certain benches within the range are designed to accommodate two or more persons working together. With this in mind the upper shelf unit is accessible from both sides.

## CREATE A RUN

Using the starter & extension method you can mix and match depths.



# INFINITE WORKBENCH SYSTEM 1000KG UDL

## CONVENIENCE

Each bench is supplied in flat pack form, the larger units having sectional worktops for ease of handling. Available in 2 lengths, 3 depths, and 3 worktop options.

## ECONOMIC

This system offers great economic advantages over standard workbench sizes e.g. the 3000 x 1200mm workbench (opposite) is the equivalent working area of x 4 1500 x 600mm workbenches.).

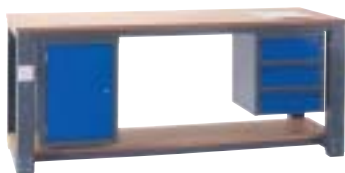

2000 x 700 Starter workbench with MDF worktop, MDF base shelf, cabinet, triple drawer & leg socket  
Order code: KDB2078BSA +C1 +D3 +LS1  
**£763.05**



3000 x 1200 Starter workbench with MDF worktop, MDF base shelf and combined cabinet & drawer unit  
Order code: KDB3028BSA + CD1  
**£620.28**



3000 x 1200 Starter workbench with MDF worktop and MDF base shelf  
Order code: KDB3028BSA  
**£776.59**



3000 x 1200 Starter workbench with MDF worktop  
Order code: KDB3028A  
**£684.59**



- HEAVY DUTY MODULAR DESIGN
- STARTER & ADD-ON BENCHES
- HEIGHT ADJUSTABLE FROM 840-940MM IN 25MM INCREMENTS
- EASY TO ADD ACCESSORIES

## ACCESSORIES

Description	Code	£
Cupboard Unit	C1	121.78
Single Drawer	D1	92.11
Two Drawer	D2	165.99
Three Drawer	D3	231.43
Cupboard / Drawer	CD1	244.19
13 Amp Socket	LS1	22.08
2000mm Tool Rail	TR20	119.24
2000mm Light & Tool Rail	LTR20	218.61
2000mm Upper Shelf	USS235	128.28
3000mm Upper Shelf	USS335	218.39
2000mm Service Duct	SD20	151.00
3000mm Service Duct	SD30	199.05

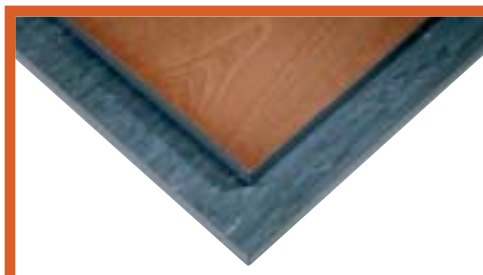

## WORKTOPS

- A = 30mm thick hardwood veneer top.  
2mm veneer surface on 28mm composite core.  
Edge banded in 2mm thick grey plastic
- B = 30mm thick industrial marble grey lino.  
2mm vinyl surface on 28mm composite core.  
Edge banded in 2mm thick grey plastic.
- C = 25mm thick plain cut MDF

**All base shelves are 18mm thick plain cut MDF**



13 Amp Socket  
Order code: LS1



Pre-punched to accommodate pipe work



# MEDIUM DUTY SQUARE TUBE WORKBENCHES 45F

The Flexistation workbench system is ideal for light assembly work or a production run. These benches arrive on site built up with above the work surface accessories supplied loose. All workbenches are 840mm high as standard, other heights are available. Frames Mid Grey 7001, Doors/Drawers Blue 5015 as standard.



1800 x 750 Laminate worktop square tube workbench  
Order code: 45F187C +

**PICTURED ACCESSORIES**

- D1 Single drawer
- C1 Cabinet
- SD18 Sloping fronted rear service duct unwired
- AP3 Accessory posts
- LP18 Louvre panel
- USS18 Upper shelf
- LU18 Light bar

**SECURITY STORAGE**

Lockable storage cabinets and drawers to encourage an efficient workstation and workplace.

**ADJUSTABLE FEET**

Adjustable feet available to correct uneven floors



**ESD**  
Worktop options G

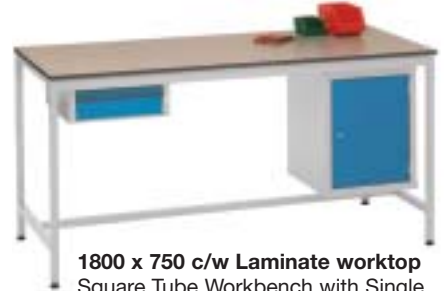

**1800 x 750 c/w Laminate worktop**  
Square Tube Workbench with Single Drawer & Cabinet  
45F187C + D1 + C1

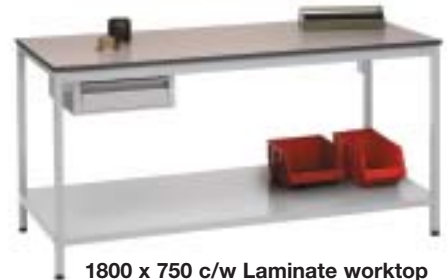

**1800 x 750 c/w Laminate worktop**  
Square Tube Workbench with Base Shelf & Drawer  
45F187C + BS18 + D1



**1800 x 750 c/w Laminate worktop**  
Square Tube Workbench with Base Shelf  
45F187C + BS18

SIZES		ORDER CODE							
L(mm)	W(mm)	Basic Benches*	A £	B £	C £	D £	E £	F £	G £
1200	600	45F126*	346.18	390.06	264.97	323.70	308.31	241.17	345.96
1200	750	45F127*	387.52	421.95	302.08	335.99	326.99	250.90	372.83
1200	900	45F129*	366.76	437.01	323.74	357.16	345.75	260.80	404.06
1500	600	45F156*	378.31	450.94	303.17	341.31	392.38	258.28	373.97
1500	750	45F157*	391.05	474.28	319.08	373.84	402.49	268.24	455.92
1500	900	45F159*	396.85	457.78	351.86	392.98	403.93	278.07	466.33
1800	600	45F186*	392.43	457.78	312.38	351.11	346.06	271.70	448.21
1800	750	45F187*	403.16	470.36	316.56	368.47	400.37	283.57	466.46
1800	900	45F189*	408.72	487.82	355.72	403.07	394.17	293.17	483.12

\*choose a worktop and add A, B, C, D, E, F, G

**MD WORKTOPS**

- A = 1.5mm Steel on composite core
- B = 1.5mm Stainless steel on composite core
- C = 18mm Laminate
- D = 18mm Lino
- E = 24mm Plywood
- F = 24mm MDF
- G = 18mm ESD Laminate



# MEDIUM DUTY CANTILEVER WORKBENCHES 46M

The Maxistation workbench system is ideal for light assembly work or a production run. These benches are designed to optimise space under the work surface, especially when used by seated operators. All workbenches are 840mm high as standard, other heights are available. Frames Mid Grey RAL 7001, Doors/Drawers Blue RAL 5015 as standard.



1800 x 750 Laminate worktop square tube workbench  
Order code: 45F187C +

**PICTURED ACCESSORIES**

- D1 Single drawer
- C1 Cabinet
- SD18 Sloping fronted rear service duct unwired
- AP3 Accessory posts
- LP18 Louvre panel
- USS18 Upper shelf
- LU18 Light bar

**SECURITY STORAGE**

Lockable storage cabinets and drawers to encourage an efficient workstation and workplace.

**ADJUSTABLE FEET**

Adjustable feet available to correct uneven floors



**ESD**  
Worktop options G



**1800 x 750 c/w Laminate worktop**  
Cantilever Workbench  
46M187C + D1 + C1

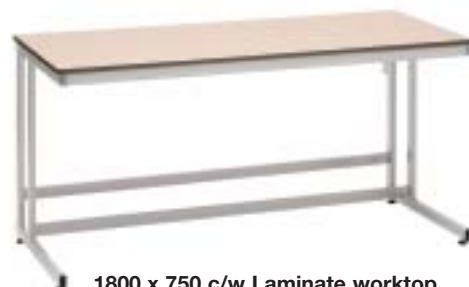

**1800 x 750 c/w Laminate worktop**  
Cantilever Workbench  
46M187C



**1800 x 750 c/w Laminate worktop**  
Cantilever Workbench  
46M187C + D2 + C1

SIZES		ORDER CODE							
L(mm)	W(mm)	Basic Benches*	A £	B £	C £	D £	E £	F £	G £
1200	600	46M126*	377.11	421.18	306.23	360.17	341.93	279.45	353.08
1200	750	46M127*	388.24	451.32	342.54	376.59	359.80	288.44	371.09
1200	900	46M129*	396.79	466.02	364.72	397.29	377.73	297.36	407.20
1500	600	46M156*	407.84	479.40	343.61	381.80	422.32	295.13	376.67
1500	750	46M157*	420.02	492.09	359.84	413.60	432.01	305.02	453.82
1500	900	46M159*	425.57	501.73	391.25	432.33	434.40	314.42	467.94
1800	600	46M186*	431.60	485.95	352.61	391.38	378.04	308.32	451.04
1800	750	46M187*	421.36	498.29	356.70	408.35	429.99	319.66	468.50
1800	900	46M189*	431.60	514.68	394.89	442.19	424.57	328.82	484.44

\*choose a worktop and add A, B, C, D, E, F, G, denoting which you require.

**MD WORKTOPS**

- A = 1.5mm Steel on composite core
- B = 1.5mm Stainless steel on composite core
- C = 18mm Laminate
- D = 18mm Lino
- E = 24mm Plywood
- F = 24mm MDF
- G = 18mm ESD Laminate



If not standard, please specify colour choice at time of order



# WORKBENCH ACCESSORIES

A comprehensive range of accessories for storage above and below the work surface, lighting and power supply. Workbench accessories are factory fitted and not for retro-fit. Above worksurface accessories are supplied detached for transportation purposes.



### BASE SHELVES

Code	Length(mm)	£
BS12	1200	56.69
BS15	1500	72.76
BS18	1800	78.81

Base shelves are 1.2mm thick steel sheet



### DRAWERS - 25KG UDL

Code	Description	£
D1	Single drawer	92.11
D2	Double drawer	165.99
D3	Triple drawer	231.43
D4	Quad drawer	336.89
C1*	Cabinet:	121.78
	C1 Cabinet Size - External D450 x W450 x H600mm	
CD1*	Cabinet drawer:	244.19
	CD1 Cabinet Size - External D450 x W450 x H600mm	
	Drawer Size - Internal D420 x W355 x H100mm	

\*Includes shelf

### CASTORS

Code	Description	£
C100	x 4 100mm	79.81



### 100MM RETAINING LIP THREE SIDES

Code	Description	£
SL12	Retaining lip	29.11
SL15	Retaining lip	32.91
SL18	Retaining lip	36.71



### PRE WIRED SERVICE DUCT

Sloping fronted rear service duct wired

Code	Length(mm)	£
WD12	1200	339.60
WD15	1500	385.88
WD18	1800	441.42

Pre wired with RCB 2 x 2 sockets + cable.



### ELECTRICS

Sloping fronted rear service duct unwired

Code	Length(mm)	£
SD12	1200	66.25
SD15	1500	69.65
SD18	1800	73.18

Supplied unwired, for fitting by a suitably qualified electrician.



### ACCESSORY POSTS

Code	Height(mm)	£
AP1	1000	57.60
AP2	1500	62.16
AP3	2000	65.21

Adjustable and supplied in pairs.



### LOUVRE PANELS†

Code	Length(mm)	£
LP12	1200	65.62
LP15	1500	79.91
LP18	1800	99.76



### PERFORATED PANELS†

Code	Length(mm)	£
TP12	1200	65.62
TP15	1500	79.91
TP18	1800	99.76



### UPPER SHELVES††

Code	Length(mm)	£
USS12*	1200	46.70
USS15*	1500	55.50
USS18*	1800	66.95

\*Upper shelves are 2mm thick steel. Laminate & MDF also available.



### LIGHT BARS†††

Code	Length(mm)	£
LU12	1200	96.44
LU15	1500	98.28
LU18	1800	100.62

Supplied unwired, for fitting by electrician.

### LOUVRED CATEGORY 2 LIGHT BARS†††

Code	Length(mm)	£
CU12	1200	145.23
CU15	1500	146.81
CU18	1800	148.40

Supplied unwired, for fitting by electrician.



### VICE PLATE

Code	Description	£
VP	Vice plate	13.29

### VICES INC. VICE PLATE

BV75VP	75mm Engineers	52.90
BV15VP	150mm Engineers	98.90
BW7VP	7" wood	79.35
BW9VP	9" wood	104.65



### PLASTIC BINS (Per Pack)

Code	L	W	D(mm)	£	QTY
BB2	165	100	75	46.69	20
BB3	240	150	125	50.37	10
BB4	355	220	125	65.21	10
BB5	355	200	175	78.54	10

Price per pack + £20.00 carriage

### WORKBENCH OPTIONS

Medium & heavy duty workbenches are available in the following options, please add:

Code	Description	£
SDC	Sliding Door	474.39
FP	Flat Pack	46.28

### †ACCESSORY POSTS REQUIRED

† AP1 Required  
 †† AP2 Required  
 ††† AP3 Required



Accessories page 31



If not standard, please specify colour choice at time of order



# MEDIUM & HEAVY DUTY WORKBENCHES

A comprehensive range of fully welded angle iron construction workbenches with a variety of worktop options and accessories. All workbenches are 840mm high as standard, other heights available. Popular models - available in all sizes from 1200mm long x 600mm wide to 1800mm long x 900mm wide. All workbenches are 840mm high as standard, other heights available. Frames Mid Grey RAL 7001, Doors/Drawers Blue RAL 5015 as standard.

1800 x 750 c/w  
Laminate worktop

Order code MD: 40187A +

**PICTURED ACCESSORIES**  
 D1 Single drawer  
 C1 Cabinet  
 SD18 Sloping fronted rear service duct unwired  
 AP3 Accessory posts  
 LP18 Louvre panel  
 USS18 Upper shelf  
 LU18 Light bar

**1800 x 750 c/w MDF worktop**  
 MD: 40187D + BS18  
 MD: 40187A + BS18

**1800 x 750 c/w MDF worktop**  
 MD: 40187D + BS18 + D2 + C1  
 MD: 40187A + BS18 + D2 + C1

**1800 x 750 c/w Steel worktop**  
 MD: 38187 + C1 + C3  
 MD: 42187 + C1 + C3

**1800 x 750 c/w Steel worktop**  
 MD: SDC 38187  
 MD: SDC 42187

ESD Worktop options G

## MEDIUM DUTY WORKBENCHES (500KG UDL)

Welded construction from 40 x 40 x 4mm angle iron with 2 pairs of leg supports with single bottom mounted cross rail.

SIZES		ORDER CODES		ORDER CODES							
L(mm)	W(mm)	2mm Steel Top	£	Wood Top*	A £	B £	C £	D £	E £	F £	G £
1200	600	38126	242.79	40126*	377.11	421.18	282.02	311.22	322.68	280.46	331.65
1200	750	38127	245.98	40127*	388.24	451.32	288.12	312.88	335.71	290.03	352.67
1200	900	38129	256.45	40129*	396.79	466.02	314.95	345.88	358.72	299.60	388.88
1500	600	38156	252.89	40156*	407.84	479.40	292.53	331.25	355.65	292.84	357.75
1500	750	38157	253.49	40157*	420.02	492.09	310.96	365.87	424.07	302.73	442.88
1500	900	38159	268.50	40159*	425.57	501.73	349.96	391.31	427.83	315.09	458.91
1800	600	38186	268.32	40186*	431.60	485.95	309.28	348.68	369.51	303.96	462.05
1800	750	38187	278.60	40187*	421.36	498.29	315.45	368.80	431.48	316.05	462.05
1800	900	38189	288.09	40189*	431.60	514.68	354.92	403.07	435.27	328.11	477.50

## MD WORKTOPS

- A = 1.5mm Steel on composite core
- B = 1.5mm Stainless steel on composite core
- C = 18mm Laminate
- D = 18mm Lino
- E = 24mm Plywood
- F = 24mm MDF
- G = 18mm ESD Laminate

## HEAVY DUTY WORKBENCHES (1000KG UDL)

Welded construction from 50 x 50 x 5mm angle iron with 2 pairs of leg supports with single bottom mounted cross rail.

SIZES		ORDER CODES		ORDER CODES				
L(mm)	W(mm)	3mm Steel Top	£	Wood Top*	A £	B £	C £	D £
1200	600	42126	275.03	44126*	296.96	336.53	347.87	P.O.A
1200	750	42127	288.08	44127*	307.98	351.83	373.81	P.O.A
1200	900	42129	301.13	44129*	319.23	376.72	427.02	P.O.A
1500	600	42156	292.74	44156*	310.91	371.30	428.46	P.O.A
1500	750	42157	308.13	44157*	323.22	441.08	479.76	P.O.A
1500	900	42159	323.55	44159*	334.53	447.66	446.95	P.O.A
1800	600	42186	307.73	44186*	323.27	386.50	428.47	P.O.A
1800	750	42187	325.38	44187*	333.71	449.19	489.17	P.O.A
1800	900	42189	343.04	44189*	351.33	456.72	491.22	P.O.A

## HD WORKTOPS

- 3mm Steel
- A = 24mm MDF
- B = 24mm Plywood
- C = 38mm Plywood
- D = 30mm Beech Hardwood



If not standard, please specify colour choice at time of order



# EXTRA HEAVY DUTY LARGE WORKBENCHES

Ideal for an engineering environment. These benches are of fully welded rugged construction, designed to take the everyday knocks of the industrial workplace. All workbenches are 840mm high as standard, other heights available. Frames Grey RAL 7031, Doors/Drawers Blue RAL 5015 as standard.



**MODEL 44C2 (WOOD TOP)**

1800 x 750 with 24mm MDF top, right hand cabinet and left hand drawer

Order code: 44287A +

**PICTURED ACCESSORIES**

D1 Single drawer  
C1 Cabinet

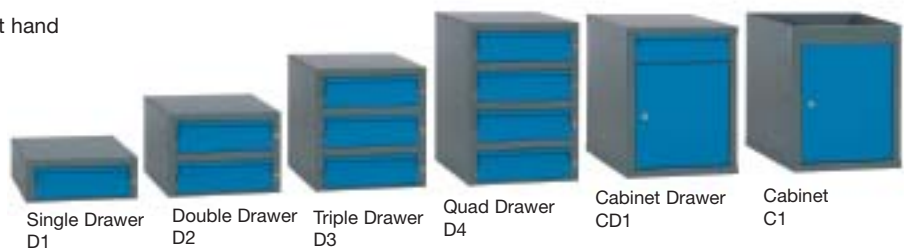

**EXTRA HEAVY DUTY (HD = 1500KG UDL)**

Welded construction from 50x50x5mm angle iron leg supports. 3 pairs supplied.

SIZES		ORDER CODES		ORDER CODES				
L(mm)	W(mm)	3mm Steel Top	£	Wood Top*	A £	B £	C £	D £
1800	750	42287	485.19	44287*	434.12	547.33	683.17	P.O.A
1800	900	42289	505.57	44289*	450.12	551.18	690.45	P.O.A
2000	750	42227	497.73	44227*	456.12	570.00	745.87	P.O.A
2000	900	42229	519.31	44229*	463.06	577.37	753.24	P.O.A
2400	750	42247	521.70	44247*	476.70	613.44	754.26	P.O.A
2400	900	42249	546.82	44249*	483.74	620.99	761.80	P.O.A
2400	1200	42242	597.03	44242*	497.77	636.10	776.93	P.O.A
3000	750	42237	557.09	44237*	P.O.A	P.O.A	P.O.A	P.O.A
3000	900	42239	588.65	44239*	P.O.A	P.O.A	P.O.A	P.O.A
3500	750	42257	588.65	44257*	P.O.A	P.O.A	P.O.A	P.O.A
3500	900	42259	622.29	44259*	P.O.A	P.O.A	P.O.A	P.O.A

\*when choosing a wooden top add A, B, C, or D to order code, denoting which finish you require.

**HD WORKTOPS**

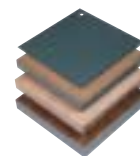

- 3mm Steel
- A = 24mm MDF
- B = 24mm Plywood
- C = 38mm Plywood
- D = 30mm Beech Hardwood



# HEIGHT ADJUSTABLE ERGONOMIC WORKBENCHES 48HA

Ideally suited to most work environments - Education, Electronics, Aerospace, Health, Light Assembly & Industrial research Laboratories etc. Frames Light Grey RAL 7035, Doors/Drawers Grey RAL 7031 as standard.



**300KG UDL**  
Satisfy requirements of Disability Discrimination Act 1995

Removable crank handle

'Put it straight to work' - supplied in built up form

Cantilever leg design for ease of movement

Sit or Stand



300mm of smooth height adjustment from 700-1000mm



1800 x 750 c/w lino worktop  
48187 + D1 + C1

WORK STANDING



WORK SEATED



Single Drawer D1

Double Drawer D2

Triple Drawer D3

Quad Drawer D4

Cabinet Drawer CD1

Cabinet C1

## WORKBENCHES

L x W(mm)	Top	Code	£
1500 x 750	18mm Laminate	48157C	659.11
1800 x 750	18mm Laminate	48187C	659.11
1500 x 750	18mm Lino	48157D	672.50
1800 x 750	18mm Lino	48187D	672.50
1500 x 750	24mm MDF	48157F	587.77
1800 x 750	24mm MDF	48187F	597.77
1500 x 750	18mm ESD Laminate	48157G	745.52
1800 x 750	18mm ESD Laminate	48187G	760.20

## DRAWERS & CABINETS

Description	Code	£
Single Drawer	D1	92.11
Double Drawer	D2	165.99
Triple Drawer	D3	231.43
Quad Drawer	D4	336.89
Cabinet	C1	121.78
Cabinet Drawer	CD1	244.19

## ACCESSORY POSTS

Description	Code	£
1000mm High	HAP1	57.60
1500mm High	HAP2	62.16
2000mm High	HAP3	65.71

## LOUVRE PANELS

Description	Code	£
1500mm Length	LP15	79.91
1800mm Length	LP18	99.76

## STEEL UPPER SHELVES

Description	Code	£
1500mm Steel Upper Shelf	USS15	55.50
1800mm Steel Upper Shelf	USS18	66.95

## ELECTRICS (unwired)

Description	Code	£
1500mm Light Bar	LU15	98.28
1800mm Light Bar	LU18	100.62
1500mm Cat2 Light Bar	CU15	146.81
1800mm Cat2 Light Bar	CU18	148.40
1500mm Service Duct	SD15	69.65
1800mm Service Duct	SD18	73.18



# TIMBER WORKBENCHES

A robust and durable workbench constructed to a very high standard. A large choice of sizes, worktop options and accessories available make it ideal for a range of applications. Protective hardwood feet supplied as standard on all benches. Build your own workbench by using the basic flat-topped bench, with the choice of three work surface options and any combination of the accessories below. Finished with 2 coats of clear lacquer.

## WORKBENCHES

L x D(mm)	Top	Code	£
1200 x 750	Plywood	BET001	351.67
1200 x 750	Lino	BET067	409.18
1200 x 750	Hardwood	BET076	477.98
1200 x 900	Plywood	BET002	386.84
1200 x 900	Lino	BET068	450.01
1200 x 900	Hardwood	BET077	525.48
1200 x 1200	Plywood	BET003	425.50
1200 x 1200	Lino	BET069	495.11
1200 x 1200	Hardwood	BET078	578.35
1500 x 750	Plywood	BET004	387.07
1500 x 750	Lino	BET070	450.10
1500 x 750	Hardwood	BET079	525.49
1500 x 900	Plywood	BET005	425.50
1500 x 900	Lino	BET071	495.11
1500 x 900	Hardwood	BET080	578.35
1500 x 1200	Plywood	BET006	468.07
1500 x 1200	Lino	BET072	544.63
1500 x 1200	Hardwood	BET081	636.18
1800 x 750	Plywood	BET007	425.50
1800 x 750	Lino	BET073	495.11
1800 x 750	Hardwood	BET082	578.35
1800 x 900	Plywood	BET008	468.08
1800 x 900	Lino	BET074	544.63
1800 x 900	Hardwood	BET083	636.18
1800 x 1200	Plywood	BET009	514.87
1800 x 1200	Lino	BET075	599.07
1800 x 1200	Hardwood	BET084	699.79

## BOTTOM SHELF (Factory fitted)

L x D(mm)	Code	£
1200 x 750	BET023	48.99
1200 x 900	BET024	51.43
1200 x 1200	BET025	54.02
1500 x 750	BET026	59.36
1500 x 900	BET027	61.35
1500 x 1200	BET028	63.33
1800 x 750	BET029	65.31
1800 x 900	BET030	67.03
1800 x 1200	BET031	69.28

## ACCESSORIES (Factory fitted)

Description	Code	£
Cupboard Unit	BET010	167.56
Drawer Unit	BET011	198.14
Security Cupboard	BET012	139.10
Tool Rack	BET013	19.88
Saw Rack	BET014	11.26
Plane Stop	BET015	30.76
Record Vice	BET016	275.09
Back Lip L1200mm	BET017	27.82
Back Lip L1500mm	BET018	36.30
Back Lip L1800mm	BET019	42.90
Back Panel L1200mm	BET020	45.25
Back Panel L1500mm	BET021	52.26
Back Panel L1800mm	BET022	63.84



1800 x 750 c/w  
hardwood worktop £  
Order code: **BET082 +** **578.35**  
**BET010 Cupboard** **167.56**  
**BET011 Drawer** **198.14**  
**BET029 Bottom Shelf** **65.31**  
**BET016 Record Vice** **275.09**  
**BET022 Back Panel** **63.84**  
**BET013 Tool Rack** **19.88**  
**BET013 Tool Rack** **19.88**

All benches are 850mm high as standard

Choice of worktops to suit all applications

Adjustable foot to allow for uneven floors

A robust and durable softwood framed timber workbench constructed to a very high standard that is practical and attractive

Ideal for a range of applications in industry, commerce, building trade and education



Back Lip  
18mm Plywood

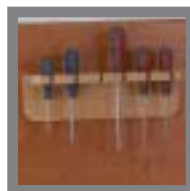

Tool Rack  
6 Slot - Back Panel  
or Side Mounted



Back Panel  
305mm High

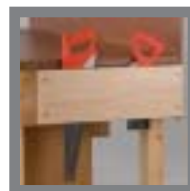

Saw Rack  
Left or Right Mounted

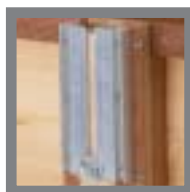

Plane Stop  
Prevents work in  
progress moving

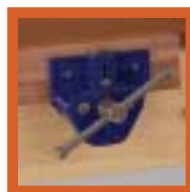

Record Vice  
175mm Jaws  
(Factory fitted only)



Security Cupboard  
Left or Right Positioning.  
Lockable



Cupboard/Drawer  
Unit

# TIMBER WORKBENCHES

### QUALITY

High quality timber workbenches constructed in medium, heavy & extra heavy duty form, from selected softwood and kiln dried hardwood with timber or steel framework.

### STANDARD OR BESPOKE

All 3 timber workbenches are available in various standard sizes. Custom building to own requirements is also available.

### FINISH

Finished in a clear lacquer, other finishes available on request. Any steel work finished in grey RAL 7031 as standard.

#### MAINTENANCE WORKBENCH

All hardwood with laminate faced worktop and retaining edge. Fitted with MDF storage cabinet.  
**Order code: TM879**  
**£1,485.00**



#### SOFTWOOD ASSEMBLY WORKBENCH

L x W x H(mm)	Code	Leg Supports	£
1800 x 760 x 900	TA879	2	805.28
3050 x 760 x 900	TA379	3	870.75
3650 x 760 x 900	TA679	4	1,040.18

#### MAINTENANCE WORKBENCH

L x W x H(mm)	Code	£
1800 x 760 x 900	TM879	1,485.00
2400 x 760 x 900	TM279	1,606.50
3050 x 760 x 900	TM379	1,803.60

#### FITTERS WORKBENCH

L x W x H(mm)	Code	£
1800 x 760 x 900	TF879	1,370.93
2400 x 760 x 900	TF279	1,760.40
3050 x 760 x 900	TF379	1,846.80

#### ALL SOFTWOOD ASSEMBLY WORKBENCH



Constructed with a 40mm (nominal) tongue and grooved worktop. Softwood bracing and cross rails on 75mm thick square legs. Supplied fully built up with a clear lacquer finish. Can be fitted with optional drawers & cabinets.

**Order code: TA379 £870.75**

#### HEAVY DUTY FITTERS WORKBENCH

Solid hardwood top on 50mm steel tubular framework with MDF storage cabinets. Optional extra - steel angle worktop, protective edge and service ducts.

**Order code: TF379 £1,846.80**  
**With optional extras £1,995.00**



# ERGONOMIC INDUSTRIAL SEATING

Comprehensive range of industrial chairs suitable for most working environments.



**UPHOLSTERED OPERATOR**

**Order code: UB2**  
Regular low lift  
430-570 gas height  
adjustment  
with 5 star  
glide base.

Shown in  
hardwearing  
charcoal fabric

£73.42



**POLYURETHANE OPERATOR**

**Order code: PB2**  
Regular low lift  
430-570  
gas height  
adjustment  
with 5 star  
glide base.

£110.73



**ESD OPERATOR**

**Order code: AB2**  
Regular low lift  
430-570  
gas height  
adjustment  
with 5 star  
glide base.

Shown in  
hardwearing  
charcoal fabric  
Compliant with  
UK & EU regulations

£99.33



**INDUSTRIAL CHAIRS & STOOL**

**Order code: IB2**  
High lift 550-800 gas  
height adjustment with  
adjustable high foot  
ring and glides.

£123.66



**Order code: UB2C**  
Low lift with castors  
450-590 gas height  
adjustment with  
5 starcastor base.

Shown in  
hardwearing  
black vinyl

£81.52



**Order code: PB2C**  
Low lift with castors  
450-590 gas height  
adjustment with  
5 star castor base.

£112.80

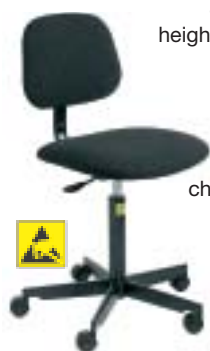

**Order code: AB2C**  
Low lift with castors  
450-590 gas  
height adjustment  
with 5 star  
castor base.

Shown in  
hardwearing  
charcoal fabric

£129.87



**Order code: IB2C**  
Low lift with castors  
470-600 gas height  
adjustment with  
5 star castor base.

**High Comfort  
for continuous  
duties**

£139.81



**Order code: UB3**  
High lift 550-800 gas  
height adjustment  
with 200mm high  
foot ring and glides.

Shown in  
hardwearing  
blue fabric

£91.78



**Order code: PB3**  
High lift 550-800  
gas height adjustment  
with 200mm high  
foot ring and glides.

£119.52



**Order code: AB3**  
High lift 550-800 gas  
height adjustment with  
200mm high foot  
ring and glides.

Shown in  
hardwearing  
blue fabric

£113.31



**Order code: IBS**  
Low lift stool 550-800  
gas height adjustment  
with 5 star  
glide base.

£95.20

**UPHOLSTERED OPERATOR**  
Optional Arms £30.00

**POLYURETHANE OPERATOR**  
Optional Arms £30.00

**ESD OPERATOR**  
Optional Arms £30.00

**INDUSTRIAL CHAIRS & STOOL**  
Optional Arms £30.00

**Fabric Colour Options**  
Charcoal, Red, Blue

**Colour**  
Black Polyurethane

**ESD Colour Fabric Options**  
Charcoal, Blue, Black Vinyl

**Vinyl Colour Options**  
Black, Red, Blue

**OPTIONS & ACCESSORIES**



# PREMIER TROLLEYS

Based on the popular Premier storage units mounted on 4 x 100mm diameter blue polyurethane tyred castors (2 braked). Welded and riveted construction from 0.9mm thick sheet steel. All cabinets are lockable and contain 1 adjustable shelf. All drawers are mounted on precision ball bearing telescopic slides offering a 40Kg (UDL) capacity. Overall size: 1200mm Length x 600mm Width x 835mm (approx.) High. Mid grey RAL 7001 carcase with Red RAL 3020 door/drawer colour.

## TROLLEYS

L x W x H(mm)	Code	Top	£
1200 x 600 x 835	PT1A	25mm Plywood	591.81
1200 x 600 x 835	PT1B	25mm Plain MDF	556.78
1200 x 600 x 835	PT2A	25mm Plywood	676.75
1200 x 600 x 835	PT2B	25mm Plain MDF	656.72
1200 x 600 x 835	PT3A	25mm Plywood	990.13
1200 x 600 x 835	PT3B	25mm Plain MDF	978.70
1200 x 600 x 835	PT4A	25mm Plywood	687.09
1200 x 600 x 835	PT4B	25mm Plain MDF	637.87
1200 x 600 x 835	PT5A	25mm Plywood	840.11
1200 x 600 x 835	PT5B	25mm Plain MDF	805.80
1200 x 600 x 835	PT6A	25mm Plywood	888.98
1200 x 600 x 835	PT6B	25mm Plain MDF	854.72



PT1A 25mm Plywood £591.81  
PT1B 25mm Plain MDF 556.78

PT2A 25mm Plywood £676.75  
PT2B 25mm Plain MDF £656.72



PT3A 25mm Plywood £990.13  
PT3B 25mm Plain MDF £978.70



PT4A 25mm Plywood £687.09  
PT4B 25mm Plain MDF £637.87



PT5A 25mm Plywood £840.11  
PT5B 25mm Plain MDF £805.80



PT6A 25mm Plywood £888.98  
PT6B 25mm Plain MDF £854.72



# GENERAL PURPOSE & MAINTENANCE TROLLEYS

This extensive range of general purpose trolleys is of fully welded construction, with tubular end frames. Overall 1060mm long x 460mm wide x 950mm high including 100mm diameter nylon swivel castors. The work surface, base and intermediate shelves can be supplied with edges lipped down if required (to be specified at time of ordering). Blue RAL 5015.

## TROLLEYS

L x W x H(mm)	Code	£
1060 x 460 x 950	GP1	159.25
1060 x 460 x 950	GP2	381.16
1060 x 460 x 950	GP3	180.03
1060 x 460 x 950	GP4	376.08
1060 x 460 x 950	GP5	503.94
1060 x 460 x 950	MT3	292.20
1060 x 460 x 950	MT3D	391.32

## AS STANDARD

All trolleys are supplied with all swivel 100mm nylon castors offering a carrying capacity of 200Kg (UDL). Rubber tyred castors offer a capacity of 150Kg (UDL).

## SHELVES

Trolley shelves are supplied with 30mm retaining lip to 4 sides as standard except GP5 and MT3 which have 30mm base lipped down.

## COLOUR OPTIONS

Supplied in blue as standard with drawers and cabinet doors in light grey, other options available.

## OPTIONS & ACCESSORIES (factory fitted)

Description	Code	£
Braked castors (pair)	BC	25.34
Rubber Mat	RM	22.03
Plastic tray	PT	33.44



Fully welded all steel 2 tier trolley  
Order code: GP1 £159.25



Fully welded all steel 2 tier trolley with double drawer  
Order code: GP2 £381.16



Fully welded all steel 3 tier trolley  
Order code: GP3 £180.03



Fully welded all steel 2 tier trolley with double cabinet  
Order code: GP4 £376.08



Fully welded 2 tier all steel trolley with triple drawer and cabinet  
Order code: GP5 £503.94



Fully welded all steel 2 tier trolley with cabinet, drawer and intermediate shelf with optional rubber tyre castors\*  
Order code: MT3D + RT Tyred £391.32



Plastic Tray



Rubber Mat



Rubber Tyre Castors (150kg UDL)



If not standard, please specify colour choice at time of order



# MEDICAL TROLLEYS

Welded construction with tubular end frames. All medical trolleys are supplied with all swivel 100mm rubber tyred castors offering a UDL capacity of 150KG. Trolley shelves are supplied with 30mm retaining lip to all 4 sides. Powder coated white RAL 9003 and supplied with appropriate warning label.



GP4FA  
£386.08

### TROLLEYS

L x W x H(mm)	Code	Description	£
460 x 460 x 950	HP1FA	Two Tier	152.53
460 x 460 x 950	HP3FA	Three Tier	170.03
1060 x 460 x 950	GP1FA	Two Tier	159.25
1060 x 460 x 950	GP3FA	Three Tier	180.03
1060 x 460 x 950	GP4FA	Full Area Cupboard	386.08



GP3FA  
£180.03



GP1FA  
£159.25



HP1FA  
£152.53



HP3FA  
£170.03

SEE FIRST AID STORAGE CABINETS PAGE 17



If not standard, please specify colour choice at time of order

